



MANUFACTURER OF LIGHTING AND VENTILATION SYSTEMS

VINTAGE LINE

Bakelite lampholders and lighting fixtures
manufactured by Eurohandel



We recommend a range of products made of the first known plastic - BAKELITE.

Our projects are characterized by a timeless appearance, high quality and diligence of the realization referring to the tradition of the Italian company VLM, which has been on the market since 1945.

EUROHANDEL as one of the few companies in the world, has the experience and knowledge necessary to process BAKELITE by pressing.



Bakelite lampholders

PAGES: 3-9

Bakelite and Cast Iron lighting fixtures

PAGES: 10-11



ASSEMBLED bakelite lampholders



MADE IN THE EU

Assembled bakelite lampholder E27 with screw terminals and cap with metal nut M10x1

----- Available colours -----



--Available on request--

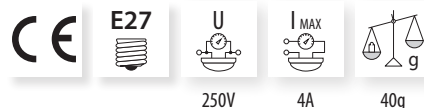

5050R

5055R

5057R

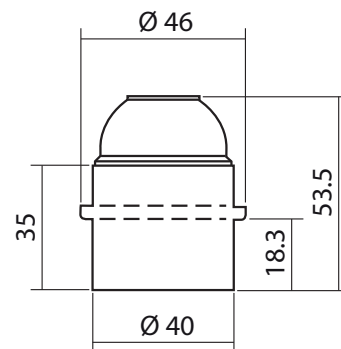

| | Product description | |
|-------|--|----|
| 5050R | E27 lampholder with smooth body | 50 |
| 5055R | E27 lampholder with threaded body | 50 |
| 5057R | E27 lampholder with half threaded body | 50 |

Assembled bakelite lampholder E14 with screw terminals and cap with metal nut M10x1

----- Available colours -----



--Available on request--

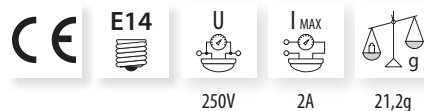

5070R

5075R

5077R

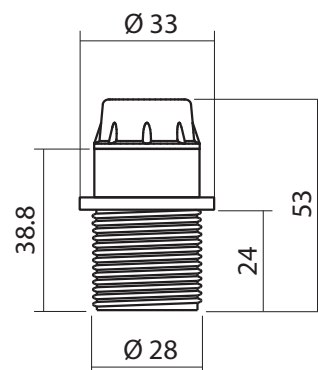

| | Product description | |
|-------|--|-----|
| 5070R | E14 lampholder with smooth body | 100 |
| 5075R | E14 lampholder with threaded body | 100 |
| 5077R | E14 lampholder with half threaded body | 100 |

UNASSEMBLED bakelite lampholders



MADE IN THE EU

Unassembled bakelite lampholder E27 - 7000 series with screw terminals and cap with metal nut M10x1.

COMPONENTS IN 3 SEPARATED BOXES.

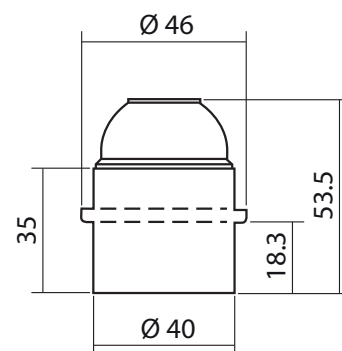

E27 smooth body



| | | |
|------------|-------|------|
| | | |
| CAM/7175/E | 18,4g | 1000 |

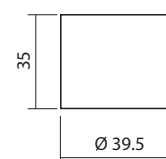

E27 threaded body



| | | |
|------------|-----|------|
| | | |
| CAM/7200/E | 17g | 1000 |

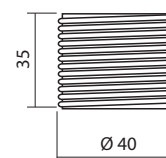

E27 half threaded body



| | | |
|------------|-------|------|
| | | |
| CAM/7350/E | 21,1g | 1000 |

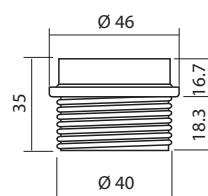





UNASSEMBLED bakelite lampholders



MADE IN THE EU 

E27 Screw terminals - thermoplastic contact base



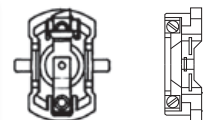

| | | | | |
|--|---|---|--|---|
|  INDEX |  |  |  |  |
| PST/7000/M1 | 250V | 4A | 40g | 100 |



Metal nut M10x1 cap



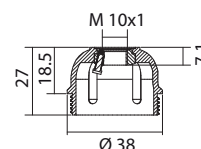

| | | |
|--|---|---|
|  INDEX |  |  |
| CAP/7000 | 14,5g | 1000 |



Metal nut M10x1 cap with earth terminal



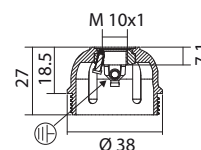

| | | |
|--|---|---|
|  INDEX |  |  |
| CAP/7000/T | 17,5g | 1000 |



Metal nut M10x1 cap with side hole Ø7



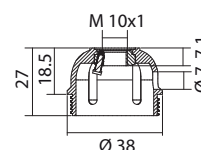

| | | |
|--|---|---|
|  INDEX |  |  |
| CAP/7000/F | 16,3g | 1000 |





Metal nut M10x1 cap with earth terminal and side hole Ø7

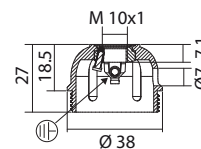

| | | |
|--|---|---|
|  INDEX |  |  |
| CAP/7000/T/F | 16,6g | 1000 |



Metal nut M10x1 cap - high

| | | |
|--|---|---|
|  INDEX |  |  |
| CAP/7000/H | 20g | 25 |

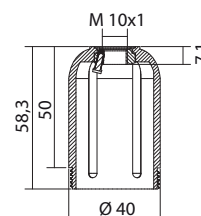

UNASSEMBLED bakelite lampholder with switch

MADE IN THE EU 



Unassembled bakelite lampholder E27 - 7000/H4 series - rocker switch with screw terminals and cap with metal nut M10x1

COMPONENTS IN 1 BOX.



----- Available colours -----



--Available on request--

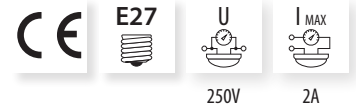

5090

5091

5092

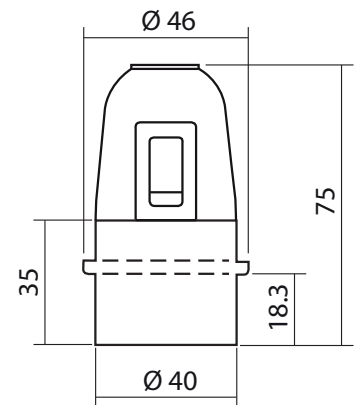

Product description



| | Product description | g | # |
|------|--|-------|----|
| 5090 | 7000/H4 lampholder with smooth body | 57,4g | 25 |
| 5091 | 7000/H4 lampholder with threaded body | 56,5g | 25 |
| 5092 | 7000/H4 lampholder with half threaded body | 60,1g | 25 |

Unassembled bakelite lampholder E27 - 7000/HT series - pull cord switch with screw terminals and cap with metal nut M10x1

COMPONENTS IN 1 BOX.



----- Available colours -----



--Available on request--

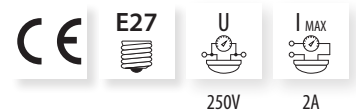

5093

5094

5095

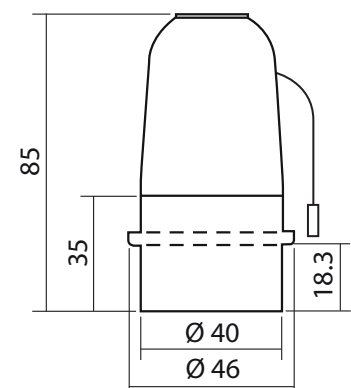

Product description



| | Product description | g | # |
|------|--|-------|----|
| 5093 | 7000/HT lampholder with smooth body | 68,1g | 25 |
| 5094 | 7000/HT lampholder with threaded body | 67,2g | 25 |
| 5095 | 7000/HT lampholder with half threaded body | 70,8g | 25 |

ASSEMBLED bakelite lampholders



MADE IN THE EU

E27 lampholder for lighting chains - piercing terminals

Available colours



* 40W 250V 4A 32,4g H05RN2-F 2x1,5mm²

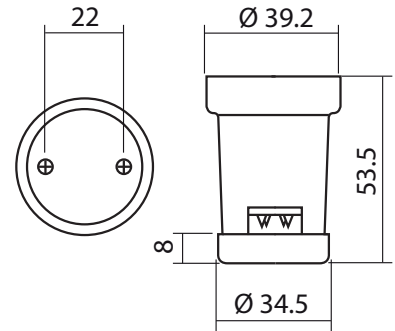

Product description



| | | |
|------------|--|-----|
| DU/5727 | E27 lampholder for lighting chains with unscrewable screws | 500 |
| DU/5727/VV | E27 lampholder for lighting chains with Philips screws | 500 |

* IP44 with gasket 393/A/N only (sold separately)

393/A/N* - Rubber gasket - to make lampholder 5727 as IP44



Product description



| | | | |
|---------|--|------|-----|
| 393/A/N | Rubber gasket for DU/5727 or DU/5727VV | 4,8g | 500 |
|---------|--|------|-----|

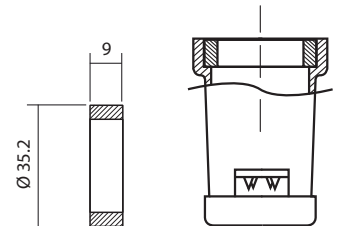

* Fix the inside gasket by silicone glue



UNASSEMBLED bakelite lampholders



MADE IN THE EU

Unassembled bakelite lampholder E14 - 3000 series with screw terminals and cap with metal nut M10x1.

COMPONENTS IN 3 SEPARATED BOXES.

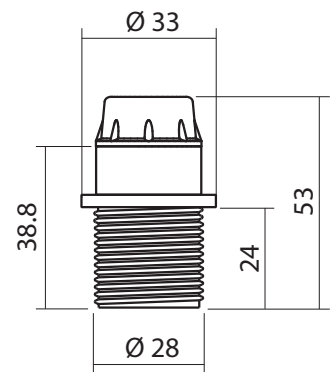

E14 smooth body



| | | |
|------------|-----|------|
| | | |
| INDEX | g | # |
| CAM/3175/E | 13g | 1500 |

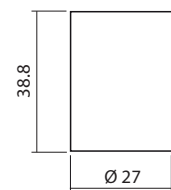

E14 threaded body



| | | |
|------------|-----|------|
| | | |
| INDEX | g | # |
| CAM/3200/E | 13g | 1500 |

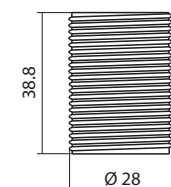

E14 half threaded body



| | | |
|------------|-------|------|
| | | |
| INDEX | g | # |
| CAM/3250/E | 14,5g | 1500 |

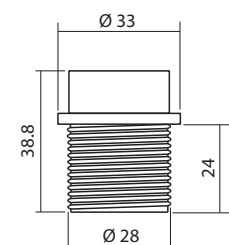

UNASSEMBLED bakelite lampholders



MADE IN THE EU

E14 Screw terminals - thermoplastic contact base



| | | | | |
|-------------|------|----|------|------|
| INDEX | | | | |
| PST/3000/M1 | 250V | 2A | 3,2g | 1500 |

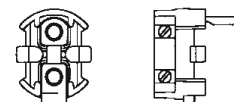

Metal nut M10x1 cap



| | | |
|----------|------|------|
| INDEX | | |
| CAP/3000 | 8,3g | 1500 |

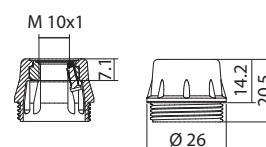

Metal nut M10x1 cap with side hole Ø6



| | | |
|------------|------|------|
| INDEX | | |
| CAP/3000/F | 9,1g | 1500 |

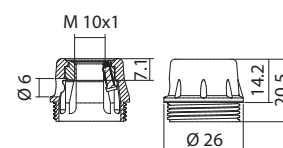

Metal nut M10x1 cap - high



| | | |
|--------------|-------|------|
| INDEX | | |
| CAP/3000/H19 | 10,4g | 1500 |

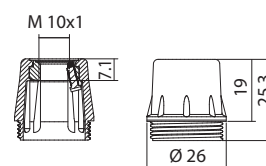

Thermoplastic shade rings for bakelite lampholders

----- Available colours -----



--Available on request--

Thermoplastic shade ring Ø58



| | | |
|---------|------|------|
| INDEX | | |
| D/73P/N | 6,3g | 1000 |

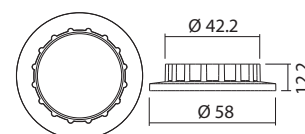

Thermoplastic shade ring Ø43



| | | |
|---------|------|------|
| INDEX | | |
| D/31P/N | 3,5g | 1000 |



CAST IRON LIGHTING FITTINGS

OVAL60 OVAL100 SAUNA



7040G

7063G

7061G

MADE IN THE EU

7040G

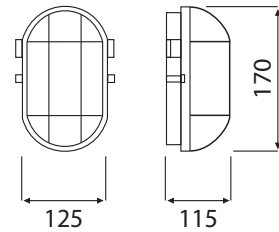

7061G

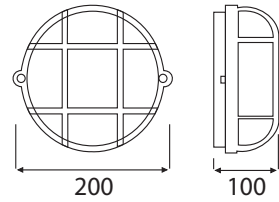
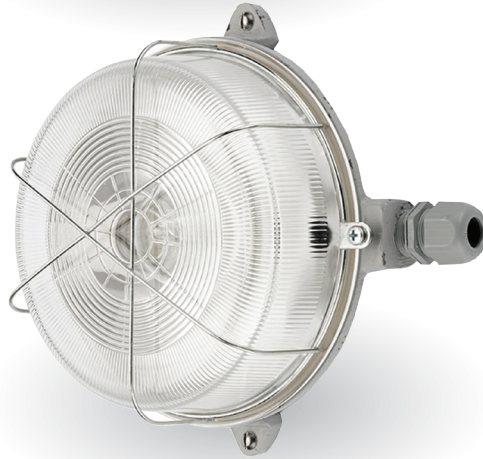

7063G

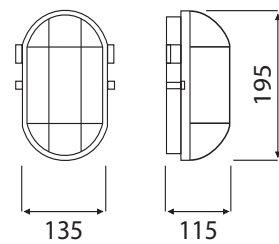

----- Available colours -----



Available on request

| TYP | INDEX | U | P _{MAX} | CAST IRON | | METAL | kg | # | |
|--------------|---------|-------|------------------|---------------|-------------|-----------|----|---------|---|
| 7040G | A1180 | 230V~ | 100W | GRAY | TRANSPARENT | GLASS | ✓ | 1,16 kg | 8 |
| | A1180-M | 230V~ | 100W | GRAY | OPAL | GLASS | ✓ | 1,18 kg | 8 |
| 7063G | A1280 | 230V~ | 100W | GRAY | TRANSPARENT | GLASS | ✓ | 1,6 kg | 6 |
| | A1280-M | 230V~ | 100W | GRAY | OPAL | GLASS | ✓ | 1,63 kg | 6 |
| 7061G | A2880 | 230V~ | 100W | GRAY | TRANSPARENT | GLASS | ✓ | 2,15 kg | 4 |
| | A2880-M | 230V~ | 100W | GRAY | OPAL | GLASS | ✓ | 2,18 kg | 4 |

BAKELITE LIGHTING FITTINGS



OVAL60 OVAL100 SAUNA

E27



7040B

7063NB

7061N, 7061NC

MADE IN THE EU 

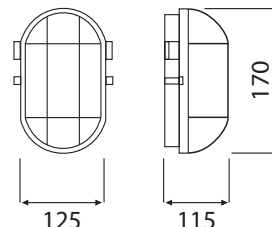
7040B



7061N
7061NC

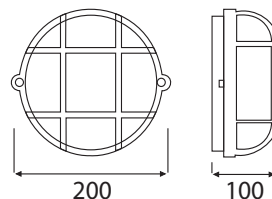



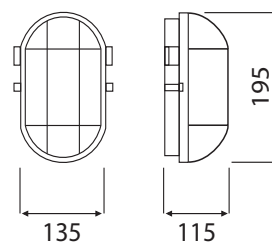





7063NB



Available colours



| TYP |  |  |  | BAKELITE  |  | METAL  |  kg |  | |
|---------------|---|---|---|---|---|--|--|---|----|
| 7040B | A1160CZ | 230V~ | 60W | BLACK | TRANSPARENT | GLASS | ✓ | 0,57kg | 12 |
| | A1160CZ-M | 230V~ | 60W | BLACK | OPAL | GLASS | ✓ | 0,57kg | 12 |
| 7063NB | A1230CZ | 230V~ | 100W | BLACK | TRANSPARENT | GLASS | ✓ | 0,70kg | 12 |
| | A1230CZ-M | 230V~ | 100W | BLACK | OPAL | GLASS | ✓ | 0,70kg | 12 |
| 7061N | A2820CZ | 230V~ | 100W | BLACK | TRANSPARENT | GLASS | ✓ | 0,90kg | 12 |
| | A2820CZ-M | 230V~ | 100W | BLACK | OPAL | GLASS | ✓ | 0,92kg | 12 |
| 7061NC | A2810CZ | 230V~ | 100W | BLACK | TRANSPARENT | GLASS | | 0,87kg | 12 |
| | A2810CZ-M | 230V~ | 100W | BLACK | OPAL | GLASS | | 0,89kg | 12 |



PPHU EUROHANDEL
41-905 Bytom, ul. Św. Elżbiety 6

Telefon/Fax: +48 32 281 52 39, e-mail: export@eurohandel.pl



www.eurohandel.pl