

# VINTAGE LINE

MOSIĄDZ

ŻELIWO

BAKELIT



## Oprawy i girlandy oświetleniowe

STRONY: 3-11



## Oprawki bakelitowe

STRONY: 12-19



Polecamy gamę produktów wykonanych z pierwszego znanego człowiekowi tworzywa sztucznego - BAKELITU.

Nasze realizacje charakteryzują się ponadczasowym wyglądem oraz wysoką jakością i starannością wykonania nawiązującą do tradycji włoskiej firmy VLM, będącej na rynku od 1945 r.

EUROHANDEL jako jedna z nielicznych firm na świecie posiada specjalistyczny park maszynowy, doświadczenie i wiedzę niezbędną do przetwórstwa BAKELITU metodą prasowania.



# Oprawy mosiężne OKRĄGŁE

----- Dostępna kolorystyka -----



mosiądz



PRODUKT POLSKI

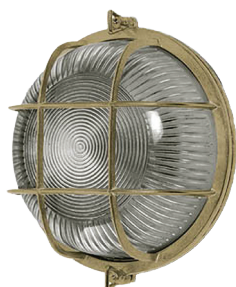

A14

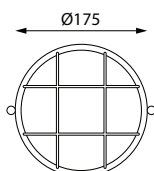

A14S

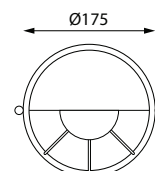

A20

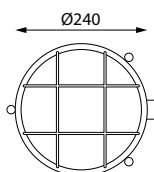

A66

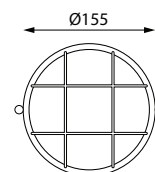

A67

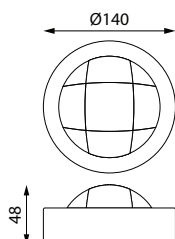

A67S

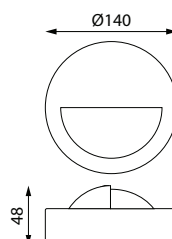

A67A

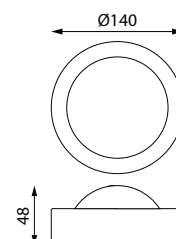

TYP	INDEX	U	E	P <sub>MAX</sub>	MOSIĄDZ	SZKŁO	MOSIĄDZ	kg	#	
OKRĄG 14	A14	230V~	E27	60W	MOSIĄDZ	PRZEźRO CZYSTY	SZKŁO	✓	1,5 kg	1
OKRĄG 14S	A14S	230V~	E27	60W	MOSIĄDZ	PRZEźRO CZYSTY	SZKŁO	✓	1,5 kg	1
BULAJ DUŻY 20	A20	230V~	E27	40W	MOSIĄDZ	MATOWY	SZKŁO	✓	2,5 kg	1
BULAJ MAŁY 66	A66	230V~	E14	40W	MOSIĄDZ	PRZEźRO CZYSTY	SZKŁO	✓	1,2 kg	1
OCZKO 67	A67	230V~	G9	60W	MOSIĄDZ	MATOWY	SZKŁO	✓	1 kg	1
OCZKO 67S	A67S	230V~	G9	60W	MOSIĄDZ	MATOWY	SZKŁO	✓	1 kg	1
OCZKO 67A	A67A	230V~	G9	60W	MOSIĄDZ	MATOWY	SZKŁO	✓	1 kg	1

# Oprawy mosiężne OWALNE

----- Dostępna kolorystyka -----



mosiądz



**PRODUKT POLSKI**

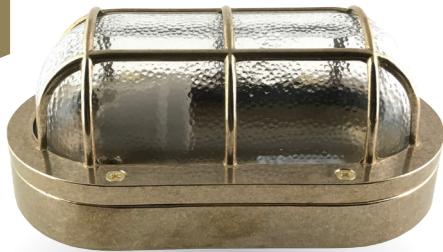

A44

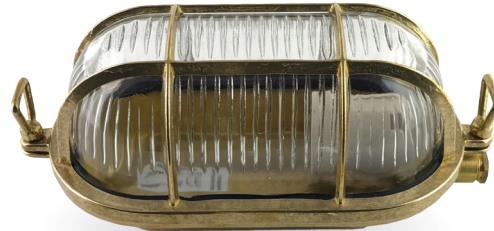
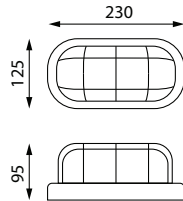

A47

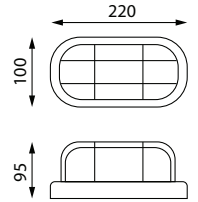

A46

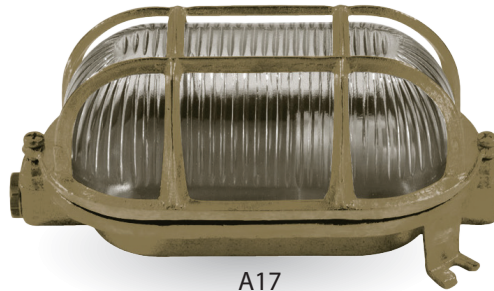
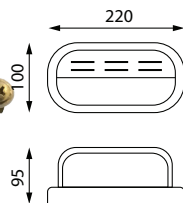

A17

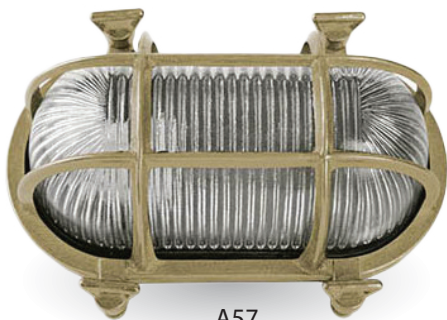
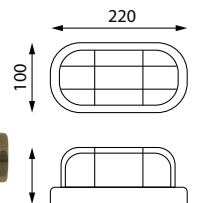

A57

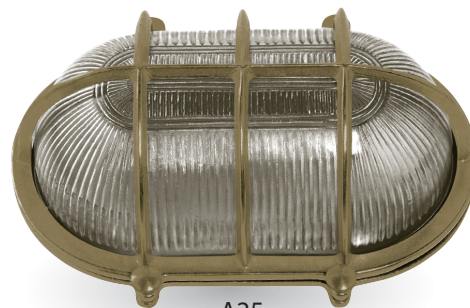
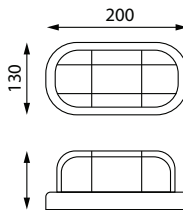

A25

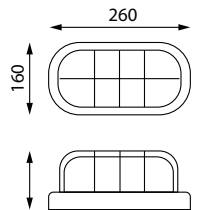

TYP	eurohandel INDEX	U		P <sub>MAX</sub>	MOSIĄDZ 		MOSIĄDZ 	kg		
OV44	A44	230V~	E27	60W	MOSIĄDZ	PRZEŹROCZYSTY	SZKŁO	✓	2,5 kg	1
OV46	A46	230V~	E27	60W	MOSIĄDZ	PRZEŹROCZYSTY	SZKŁO	✓	1,5 kg	1
OV57	A57	230V~	E27	60W	MOSIĄDZ	PRZEŹROCZYSTY	SZKŁO	✓	2 kg	1
OV47ECO	A47	230V~	E27	40W	MOSIĄDZ	PRZEŹROCZYSTY	SZKŁO	✓	1,5 kg	1
OV17	A17	230V~	E27	60W	MOSIĄDZ	PRZEŹROCZYSTY	SZKŁO	✓	1,5 kg	1
OV25	A25	230V~	E27	75W	MOSIĄDZ	PRZEŹROCZYSTY	SZKŁO	✓	2,8 kg	1

# Oprawy mosiężne WISZĄCE

----- Dostępna kolorystyka -----



mosiądz



PRODUKT POLSKI

LATARNIA 56  
IP64



A56

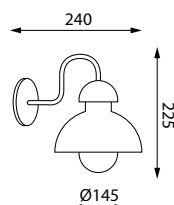

LATARNIA WISZĄCA 56K  
IP53  
łańcuch mosiężny 44cm



A56K

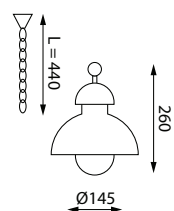

LATARNIA WISZĄCA 777KS  
IP44  
puszka mosiężna



A777KS

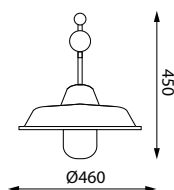

TYP	INDEX				MOSIĄDZ 		MOSIĄDZ 			
LATARNIA 56	A56	230V~	E27	60W	MOSIĄDZ	PRZEźROCYSTY	SZKŁO	✓	2,5 kg	1
LATARNIA 56K	A56K	230V~	E27	60W	MOSIĄDZ	PRZEźROCYSTY	SZKŁO	✓	1,2 kg	1
LATARNIA 777KS	A777KS	230V~	E27	150W	MOSIĄDZ	PRZEźROCYSTY	SZKŁO	✓	5 kg	1

# Oprawy mosiężne KINKIETY

----- Dostępna kolorystyka -----



mosiądz



PRODUKT POLSKI

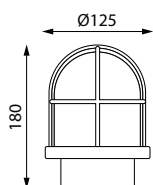

A15N

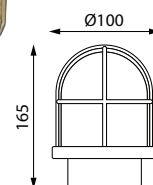

A43

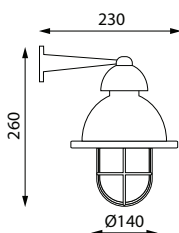

A53

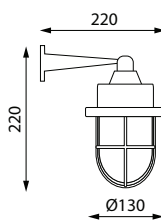

A63

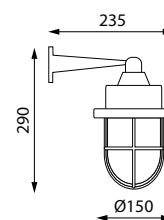

A72

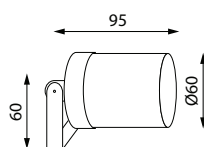

A94

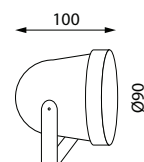

A97



TYP	eurohandel INDEX	U		P <sub>MAX</sub>	MOSIĄDZ 		MOSIĄDZ 	kg		
KINKIET 15N	A15N	230V~	E27	60W	MOSIĄDZ	PRZEŹROCZYSTY	SZKŁO	✓	1,5 kg	1
KINKIET 43	A43	230V~	E27	40W	MOSIĄDZ	PRZEŹROCZYSTY	SZKŁO	✓	1,5 kg	1
KINKIET 53	A53	230V~	E27	40W	MOSIĄDZ	PRZEŹROCZYSTY	SZKŁO	✓	2,5 kg	1
KINKIET 63	A63	230V~	E27	60W	MOSIĄDZ	PRZEŹROCZYSTY	SZKŁO	✓	2,7 kg	1
KINKIET 72	A72	230V~	E27	150W	MOSIĄDZ	PRZEŹROCZYSTY	SZKŁO	✓	2,8 kg	1
KINKIET 94	A94	230V~	GU10	50W	MOSIĄDZ	PRZEŹROCZYSTY	SZKŁO	✓	0,8 kg	1
KINKIET 97	A97	230V~	GU10	50W	MOSIĄDZ	PRZEŹROCZYSTY	SZKŁO	✓	1,2 kg	1

# AKCESORIA mosiężne

----- Dostępna kolorystyka -----



mosiądz



PRODUKT POLSKI



OPIS

WYMIARY



AN1

Łącznik mosiężny obrotowy  
- pojedynczy

Waga: 0,8 kg

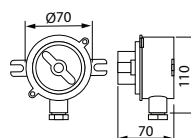

AN2

Gniazdo mosiężne z uziemieniem  
SCHUKO, 16A 230V z pokrywą

Waga: 1 kg

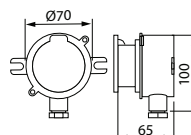

AN3/4

Mosiężna puszka rozgałęźna  
- 4 wyjścia

Waga: 1 kg

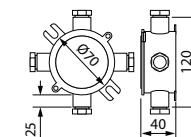

AN3/3

Mosiężna puszka rozgałęźna  
- 3 wyjścia

Waga: 0,9 kg

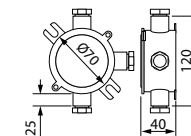

AN3/2

Mosiężna puszka rozgałęźna  
- 2 wyjścia

Waga: 0,8 kg

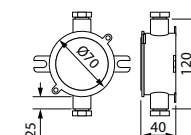

AN3/1

Mosiężna puszka rozgałęźna  
- 1 wyjście

Waga: 0,8 kg

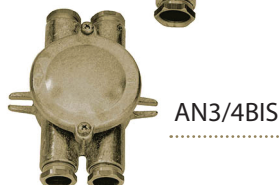
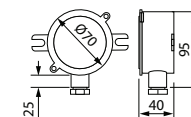

AN3/4BIS

Mosiężna puszka rozgałęźna  
4 wyjścia równoległe

Waga: 1 kg

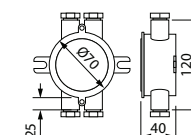

AN3/2BIS

Mosiężna puszka rozgałęźna  
2 wyjścia równoległe

Waga: 0,9 kg

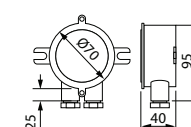

# Oprawy żeliwne

## OVAL60 OVAL100 SAUNA

7040G

7063G

7061G

E27

**PRODUKT POLSKI**

7040G

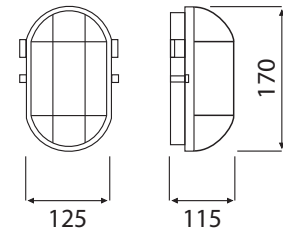

7061G

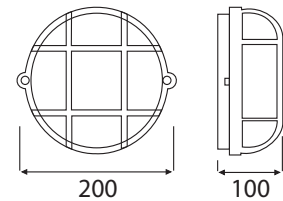
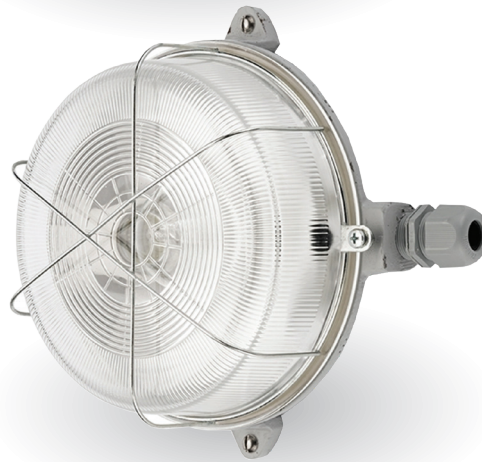

7063G

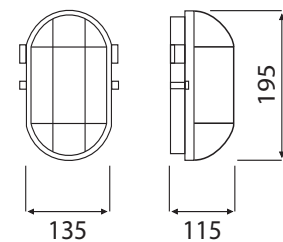

----- Dostępna kolorystyka -----



Na zamówienie

TYP	INDEX	U	P <sub>max</sub>	ŻELIWO 		METAL 	kg	#	
<b>7040G</b>	A1180	230V~	100W	SZARA	PRZEŹROCZYSTY	SZKŁO	✓	1,16 kg	8
	A1180-M	230V~	100W	SZARA	MLECZNY	SZKŁO	✓	1,18 kg	8
<b>7063G</b>	A1280	230V~	100W	SZARA	PRZEŹROCZYSTY	SZKŁO	✓	1,6 kg	6
	A1280-M	230V~	100W	SZARA	MLECZNY	SZKŁO	✓	1,63 kg	6
<b>7061G</b>	A2880	230V~	100W	SZARA	PRZEŹROCZYSTY	SZKŁO	✓	2,15 kg	4
	A2880-M	230V~	100W	SZARA	MLECZNY	SZKŁO	✓	2,18 kg	4



# Oprawa żeliwna

## OVAL-XXL

7052D

E27

**PRODUKT POLSKI**

### NOWOŚĆ

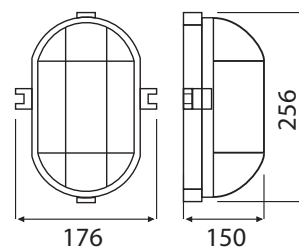

7052D

----- Dostępna kolorystyka -----



Na zamówienie



TYP	eurohandel INDEX	U	P <sub>MAX</sub>	ŻELIWO		METAL			
7052D	A7052D	230V~	200W	SZARA	PRZEźRO CZYSTY	SZKŁO	✓ Ø3mm	3,35 kg	1
	A7052D-M	230V~	200W	SZARA	MLECZNY	SZKŁO	✓ Ø3mm	3,35 kg	1

# Oprawy bakelitowe

## OVAL60 OVAL100 SAUNA

7040B

7063NB

7061N, 7061NC

E27

**PRODUKT POLSKI**

7040B

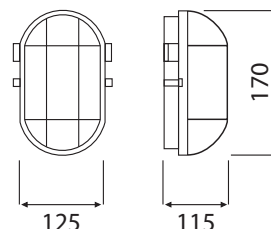
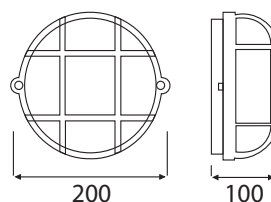
7061N  
7061NC

7063NB

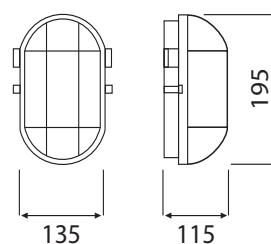

Dostępna kolorystyka

CZARNY

TYP	eurohandel INDEX	U	P <sub>MAX</sub>	BAKELIT		METAL	kg		
<b>7040B</b>	A1160CZ	230V~	60W	CZARNA	PRZEźROCYSTY	SZKŁO	✓	0,57kg	12
	A1160CZ-M	230V~	60W	CZARNA	MLECZNY	SZKŁO	✓	0,57kg	12
<b>7063NB</b>	A1230CZ	230V~	100W	CZARNA	PRZEźROCYSTY	SZKŁO	✓	0,70kg	12
	A1230CZ-M	230V~	100W	CZARNA	MLECZNY	SZKŁO	✓	0,70kg	12
<b>7061N</b>	A2820CZ	230V~	100W	CZARNA	PRZEźROCYSTY	SZKŁO	✓	0,90kg	12
	A2820CZ-M	230V~	100W	CZARNA	MLECZNY	SZKŁO	✓	0,92kg	12
<b>7061NC</b>	A2810CZ	230V~	100W	CZARNA	PRZEźROCYSTY	SZKŁO		0,87kg	12
	A2810CZ-M	230V~	100W	CZARNA	MLECZNY	SZKŁO		0,89kg	12

# Oprawy zwieszane

# VINT

PRODUKT POLSKI 



VINT 5050R/H\*







\* Dostępna kolorystyka przewodów w oplocie



Dostępna kolorystyka

\* Dostępne typy oprawek:



	EAN 				 H03VV 2 x 0,75mm <sup>2</sup>		
VINT H4-5090	5902767983754	E27	230V~	60W	CZARNY	1m	1
VINT H4-5091	5902767983891	E27	230V~	60W	CZARNY	1m	1
VINT H4-5092	5902767983907	E27	230V~	60W	CZARNY	1m	1
VINT 5050R/H	5902767983761	E27	230V~	60W	CZARNY	1m	1
VINT 5055R/H	5902767983860	E27	230V~	60W	CZARNY	1m	1
VINT 5057R/H	5902767983877	E27	230V~	60W	CZARNY	1m	1
VINT HT-5093	5902767983747	E27	230V~	60W	CZARNY	1m	1
VINT HT-5094	5902767983914	E27	230V~	60W	CZARNY	1m	1
VINT HT-5095	5902767983921	E27	230V~	60W	CZARNY	1m	1
VINT 5050R	5902767984362	E27	230V~	60W	CZARNY	1m	1
VINT 5055R	5902767984379	E27	230V~	60W	CZARNY	1m	1
VINT 5057R	5902767984386	E27	230V~	60W	CZARNY	1m	1
VINT 5070R	5902767984393	E14	230V~	60W	CZARNY	1m	1
VINT 5075R	5902767984409	E14	230V~	60W	CZARNY	1m	1
VINT 5077R	5902767984416	E14	230V~	60W	CZARNY	1m	1

# GIRLANDY OŚWIETLENIOWE



PRODUKT POLSKI 



PROFESJONALNE GIRLANDY OŚWIETLENIOWE  
CERTYFIKOWANE PRZEZ ZETOM



W OFERCIE RÓWNIEŻ GIRLANDY SPERSONALIZOWANE,  
PRODUKOWANE POD WYMIAR I WEDŁUG ŻYCZENIA KLIENTA

## ELEMENTY SYSTEMU GIRLAND:

- OPRAWKA BAKELITOWA
- WTYCZKA 16A/250V
- GNIAZDO 16A/250V  
HAK KOŃCOWY LUB  
ZAKOŃCZENIE PLASTIKOWE
- PRZEWÓD H05RNH2-F



OFERUJEMY RÓWNIEŻ  
SZEROKĄ GAMĘ ŻARÓWEK LED

# Oprawki bakelitowe ZMONTOWANE



PRODUKT POLSKI

Oprawka bakelitowa E27 do łańcuchów oświetleniowych z zaciskami przebijającymi izolację

Dostępna kolorystyka

CZARNY

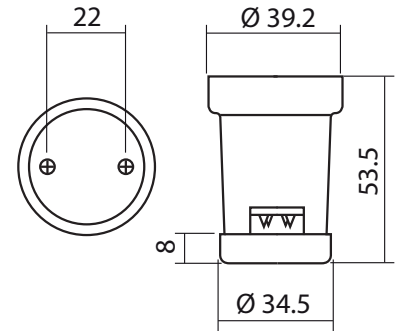
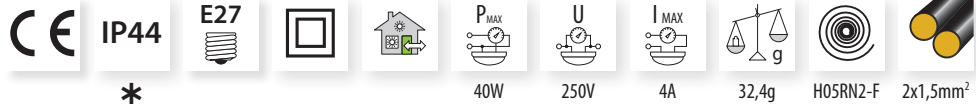

INDEX

Nazwa produktu



DU/5727	Oprawka E27 do łańcuchów oświetleniowych ze śrubami specjalnymi	500
DU/5727/VV	Oprawka E27 do łańcuchów oświetleniowych	500

\* IP44 dla opravek z wklejoną uszczelką 393/A/N (sprzedawaną oddzielnie)

## Uszczelka 393/A/N\*



INDEX

Nazwa produktu



393/A/N	Uszczelka do opravek DU/5727 i DU/5727/VV	4,8g	500
---------	---	------	-----

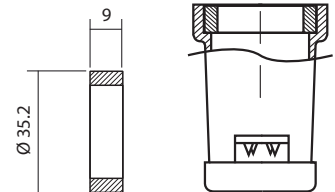

\* uszczelkę osadzić na kleju silikonowym



# Oprawki bakelitowe z przełącznikiem NIEZMONTOWANE



PRODUKT POLSKI

Oprawka bakelitowa E27 serii 7000/H4  
z metalowym wkładem M10x1  
i przełącznikiem kołkowym.  
KOMPONENTY W 1 OPAKOWANIU ZBIORCZYM.



----- Dostępna kolorystyka -----



----- Na zamówienie -----



5090

5091

5092



250V

2A

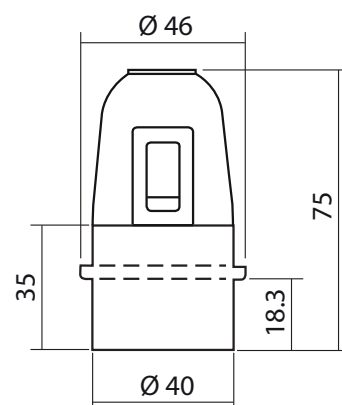

	Nazwa produktu	g	#
5090	Oprawka 7000/H4 z obudową gładką	57,4g	25
5091	Oprawka 7000/H4 z obudową gwintowaną	56,5g	25
5092	Oprawka 7000/H4 z obudową częściowo gwintowaną	60,1g	25

Oprawka bakelitowa E27 serii 7000/HT  
z metalowym wkładem M10x1  
i przełącznikiem sznurkowym.  
KOMPONENTY W 1 OPAKOWANIU ZBIORCZYM.



----- Dostępna kolorystyka -----



----- Na zamówienie -----



5093

5094

5095

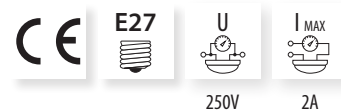

250V

2A

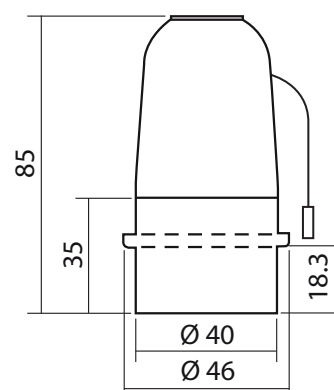

	Nazwa produktu	g	#
5093	Oprawka 7000/HT z obudową gładką	68,1g	25
5094	Oprawka 7000/HT z obudową gwintowaną	67,2g	25
5095	Oprawka 7000/HT z obudową częściowo gwintowaną	70,8g	25

# Oprawki bakelitowe ZMONTOWANE



PRODUKT POLSKI

## Oprawka bakelitowa E27 z metalowym wkładem M10x1 i terminalem zaciskowym - śrubowym

----- Dostępna kolorystyka -----



----- Na zamówienie -----



5050R

5055R

5057R

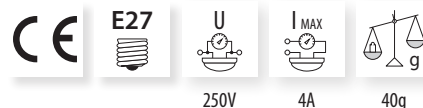

250V 4A 40g

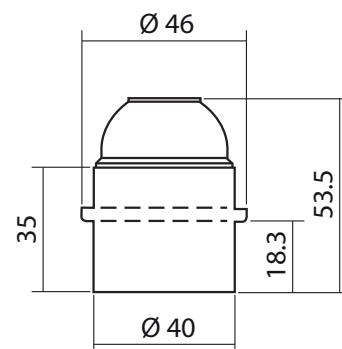

	Nazwa produktu	
5050R	Oprawka E27 z obudową gładką	50
5055R	Oprawka E27 z obudową gwintowaną	50
5057R	Oprawka E27 z obudową częściowo gwintowaną	50

## Oprawka bakelitowa E14 z metalowym wkładem M10x1 i terminalem zaciskowym - śrubowym

----- Dostępna kolorystyka -----



----- Na zamówienie -----



5070R

5075R

5077R

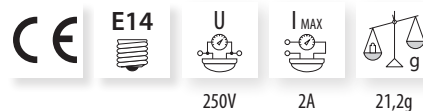

250V 2A 21,2g

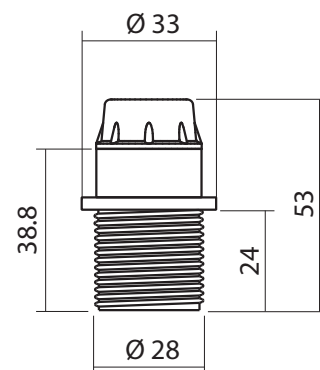

	Nazwa produktu	
5070R	Oprawka E14 z obudową gładką	100
5075R	Oprawka E14 z obudową gwintowaną	100
5077R	Oprawka E14 z obudową częściowo gwintowaną	100

# Oprawki bakelitowe NIEZMONTOWANE



PRODUKT POLSKI

Oprawka bakelitowa E27 serii 7000 z metalowym wkładem M10x1 i terminalem zaciskowym - śrubowym.

KOMPONENTY W 3 ODDZIELNYCH OPAKOWANIACH.

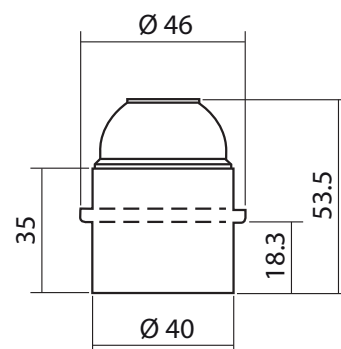

## Obudowa E27, gładka



CAM/7175/E	18,4g	1000

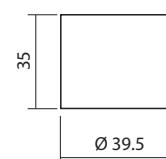

## Obudowa E27, gwintowana



CAM/7200/E	17g	1000

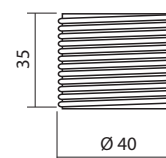

## Obudowa E27, gwint do połowy



CAM/7350/E	21,1g	1000

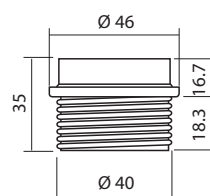



# Oprawki bakelitowe NIEZMONTOWANE



PRODUKT POLSKI

## Terminal zaciskowy, śrubowy



PST/7000/M1	250V	4A	40g	100



## Czapka



CAP/7000	14,5g	1000

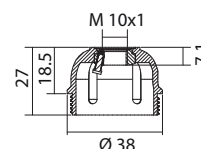

## Czapka z terminalem uziemiającym



CAP/7000/T	17,5g	1000

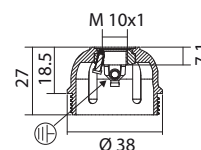

## Czapka z otworem bocznym Ø7



CAP/7000/F	16,3g	1000

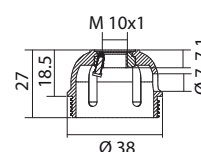

## Czapka z otworem bocznym Ø7 i terminalem uziemiającym



CAP/7000/T/F	16,6g	1000

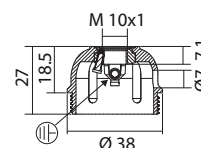

## Czapka wysoka

CAP/7000/H	20g	25

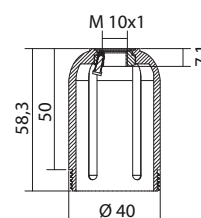

# Oprawki bakelitowe NIEZMONTOWANE



PRODUKT POLSKI

Oprawka bakelitowa E14 serii 3000 z metalowym wkładem M10x1 i terminalem zaciskowym - śrubowym.

KOMPONENTY W 3 ODDZIELNYCH OPAKOWANIACH.

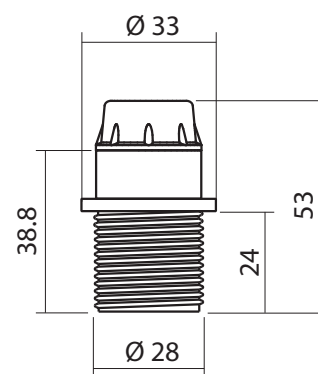
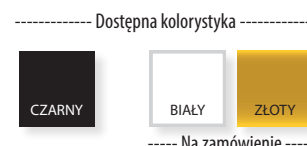

## Obudowa E14, gładka



INDEX	g	#
CAM/3175/E	13g	1500



## Obudowa E14, gwintowana



INDEX	g	#
CAM/3200/E	13g	1500

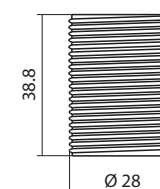

## Obudowa E14, gwint do połowy



INDEX	g	#
CAM/3350/E	14,5g	1500

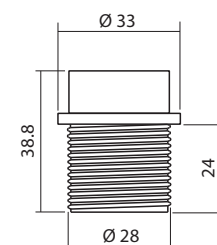

# Oprawki bakelitowe NIEZMONTOWANE



PRODUKT POLSKI

## Terminal zaciskowy E14, śrubowy



INDEX	U	I <sub>MAX</sub>	g	
PST/3000/M1	250V	2A	3,2g	1500

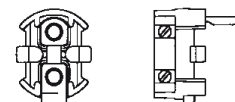

## Czapka



INDEX	g	
CAP/3000	8,3g	1500

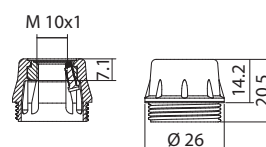

## Czapka z otworem bocznym Ø6



INDEX	g	
CAP/3000/F	9,1g	1500

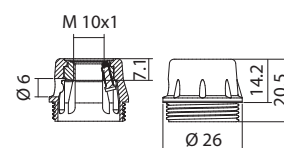

## Czapka wysoka



INDEX	g	
CAP/3000/H19	10,4g	1500

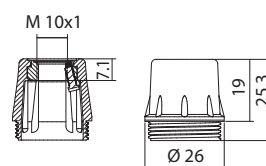

## Pierścienie termoplastyczne do oprawek bakelitowych

----- Dostępna kolorystyka -----



----- Na zamówienie -----

## Pierścień termoplastyczny Ø58



INDEX	g	
D/73P/N	6,3g	1000

E27

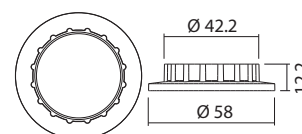

## Pierścień termoplastyczny Ø43



INDEX	g	
D/31P/N	3,5g	1000

E14



[www.eurohandel.pl](http://www.eurohandel.pl)



PPHU EUROHANDEL  
41-905 Bytom, ul. Św. Elżbiety 6

Telefon/Fax: +48 32 281 52 39, e-mail: [firma@eurohandel.pl](mailto:firma@eurohandel.pl)